

Spring isolator FR-E-56-()

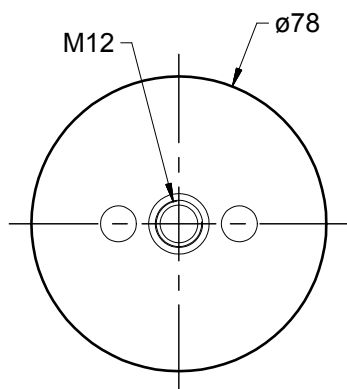

Applications

- isolation of rotating machines operating above 600 min⁻¹
- e.g. fans, motors, pumps, compressors, cooling units ...

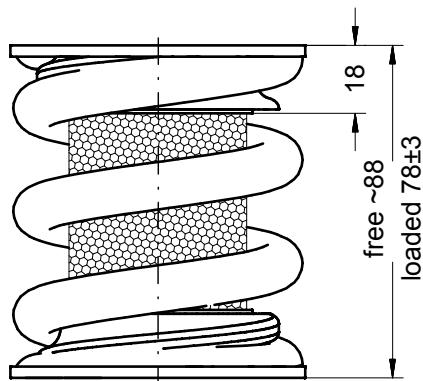

Description

- spring of spring wire, coated black
- damping cushion of stainless steel wire
- scrolls of Al-alloy
- vertical resonant frequency: 5 - 6 Hz
- weight: 0,7- 1,3 kg according to type
- elastic limit load:
2 g vertical 0,5 g horizontal

type	load
FR-E-56- 50	30 - 50 daN
FR-E-56- 80	50 - 80 daN
FR-E-56-130	80 - 130 daN
FR-E-56-200	130 - 200 daN
FR-E-56-300	200 - 300 daN
FR-E-56-400	300 - 400 daN